

ECOOME

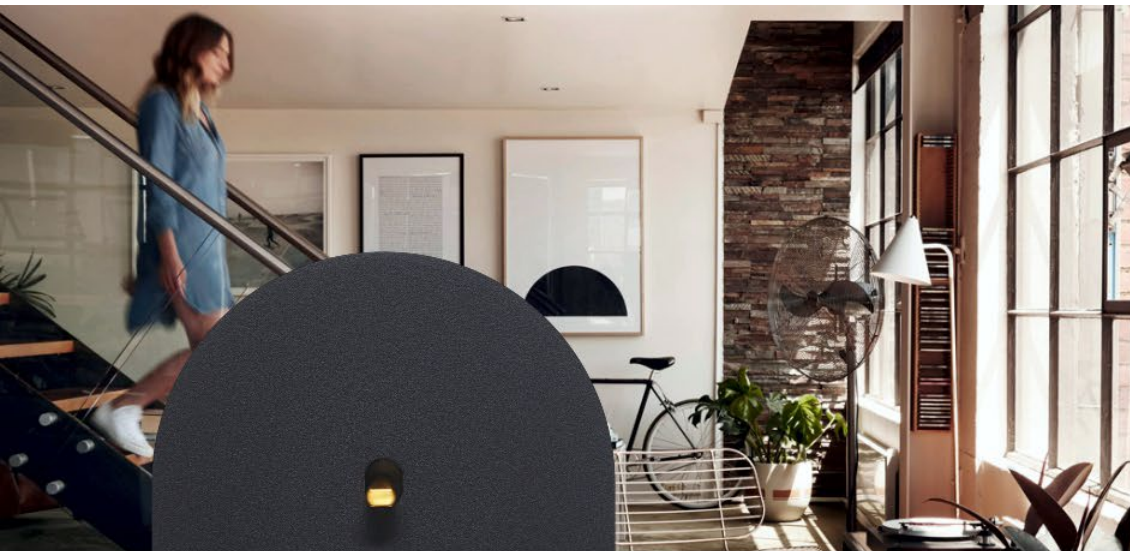

ECOOME
Interrupteurs et
prises design



Le design épuré de Vectis s'inspire du style américain à levier, adoptant une forme minimaliste.

La collection Vectis se distingue par son caractère intemporel et universel, adapté tant aux intérieurs modernes qu'aux espaces classiques. La modularité de Vectis offre une multitude de possibilités pour marier couleurs, formes et textures de cadres avec une variété étendue de mécanismes.



Attention précise à la qualité du détail.



Des milliers de configurations de cadres, interrupteurs et prises.



Cadres individuels jusqu'à 5 postes



Configurations personnalisées et couleurs disponibles sur demande.



Installation dans des boîtes standards

Carré

Vectis

Le premier de la série Vectis repose sur un cadre rectangulaire et simple. Les angles nets et la forme classique du cadre offrent une multitude de possibilités d'agencement. En faisant référence aux formes de fenêtres, de portes et de mobilier simple, cet agencement assure un intérieur cohérent et intemporel.

Comme pour toutes les gammes Vectis, nous proposons un choix de nuances de base en blanc et noir, ainsi que des finitions en aluminium brossé, doré, aluminium, titane (canon de fusil) brossé, cuivre brossé, laiton brossé ou laiton brossé vieillie. Des cadres personnalisés permettent même de les peindre dans la palette de couleurs RAL, offrant ainsi des possibilités infinies pour jouer avec les couleurs.

Le minimalisme ne se limite pas au noir et blanc, et la tendance des couleurs dans les intérieurs est toujours d'actualité.

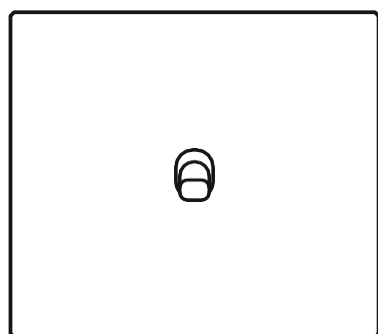

Dimensions

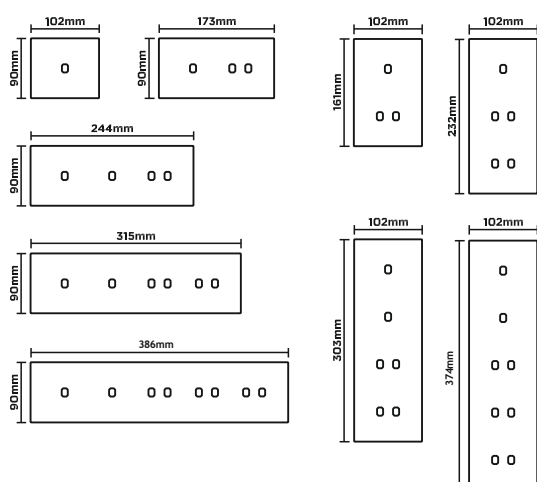

Rond

Vectis

Le cercle a toujours été perçu comme une forme parfaite. La gamme Vectis Round est une réponse à sa beauté et son esthétique universelle. Que ce soit pour des intérieurs industriels ou loft, modernes, glamour ou art déco, Vectis Round s'intégrera parfaitement à tous vos projets.

Les mécanismes sont communs aux trois gammes Vectis : Carré, Rond et Cube, offrant ainsi de riches possibilités de combiner différents styles et textures de cadres.

Vectis Round est un équipement conçu pour les clients exigeants qui apprécient le minimalisme et le caractère intemporel du design intérieur.

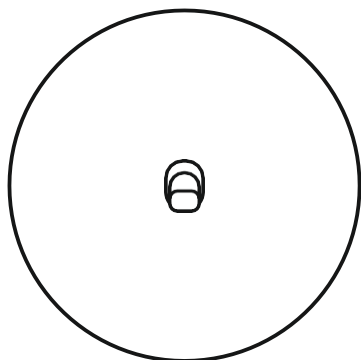

Dimensions

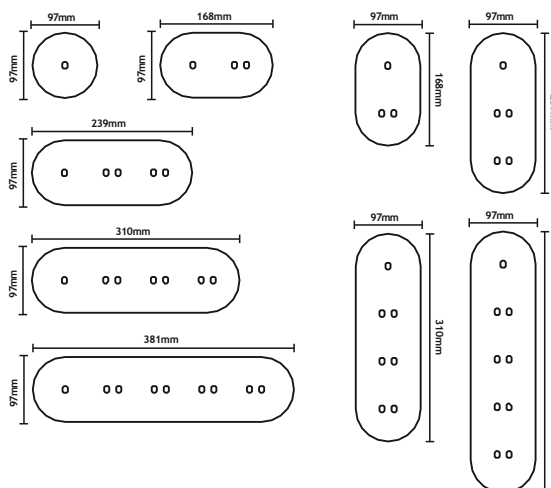

Cube

Vectis

Le benjamin de la gamme Vectis est une fusion des séries Ronde et Carré. Un rectangle aux bords arrondis a été créé comme compromis entre ces deux styles.

Vectis Cube présente un aspect plus léger et contemporain, tout en conservant son caractère minimaliste.

Cette nouvelle forme de cadre est née des échanges et rencontres avec nos clients.

Vectis Cube s'intègre parfaitement aussi bien en blanc et noir qu'en nouvelles teintes RAL et NCS.

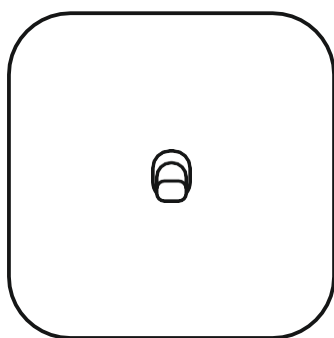
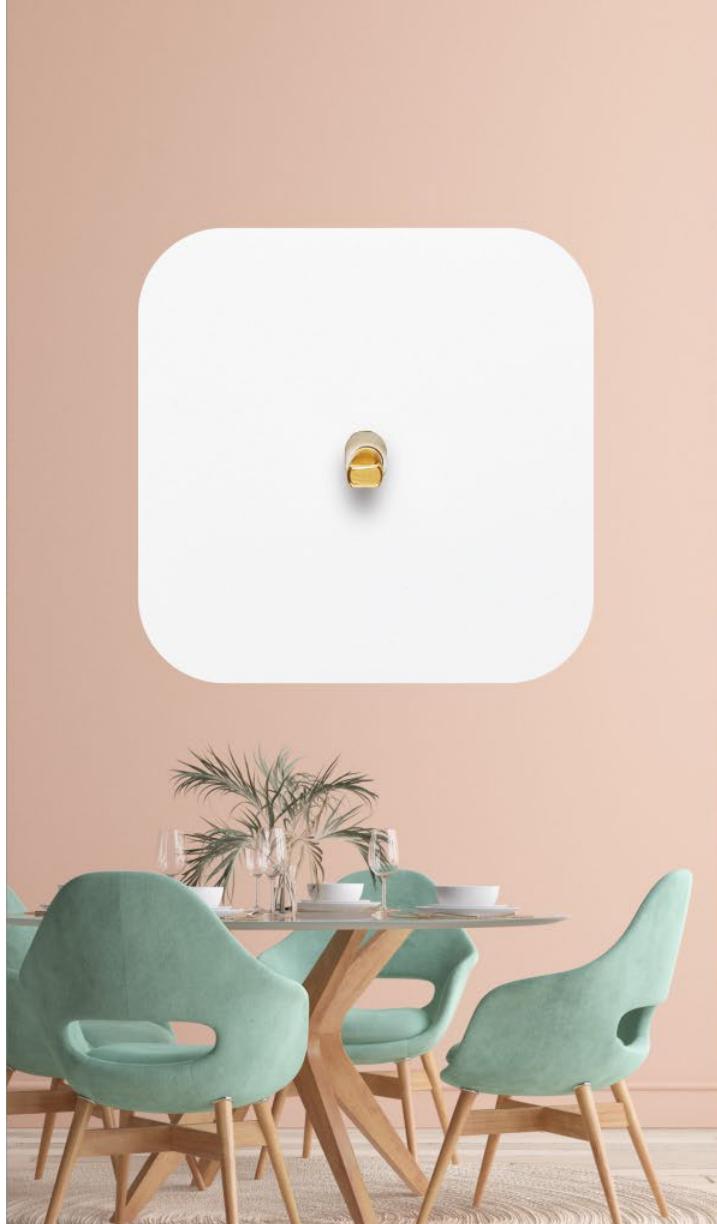

Dimensions

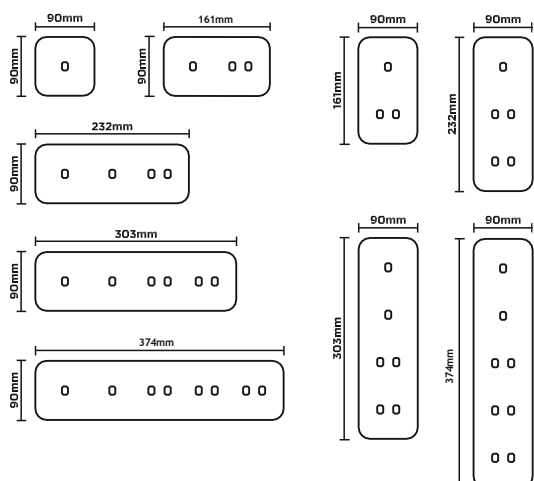

CADRES – NOIR / BLANC



NOIR
RAL 9005
TEXTURE FINE



BLANC
RAL 9016
TEXTURE FINE

CADRES - BROSSÉS



LAITON



ALUMINIUM



TITANE
(canon de fusil)



CUIVRE



BRUN

CADRES - EFFETS



LAITON VIEILLI



ROUILLE



PATINÉ 02



PATINÉ 03



PATINÉ 04

CADRES - RAL | NCS

POUDRÉ- TEXTURE FINE



COULEURS

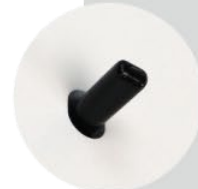

NOIR



BLANC



DORÉ



PATINÉ



CHROMÉ

COULEURS DES LEVIERS



BLANC



NOIR



CHAMPAGNE



DORÉ



GRAPHITE



ALUMINIUM

COULEURS DES ENJOLIVEURS

MÉCANISMES



SIMPLE LEVIER

Interrupteur va et vient
Permutateur
Bouton poussoir

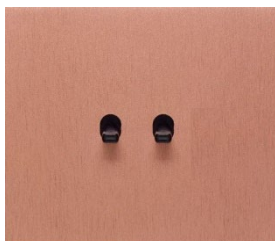

DOUBLE LEVIER

Double interrupteur va et vient
Double permutateur
Double bouton poussoir
Commande volets



PRISES

Françaises, 2P+N
Prises Schuko



MINIMALISTE

RJ 45 CAT. 5, RJ 45 CAT. 6, TV, SAT, HDMI, USB TYPE A ou C

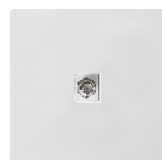
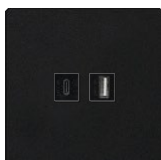
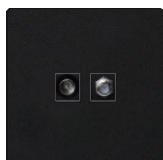
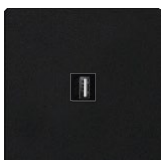
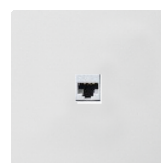
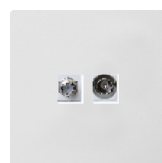
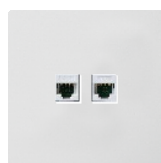
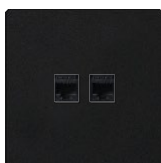
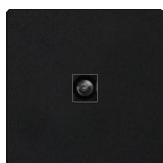
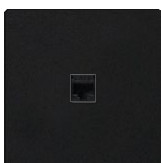

Exemple de configurations

Cadre 2 postes horizontal

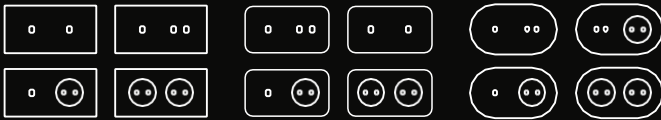

Cadre 2 postes vertical



Cadre 3 postes horizontal

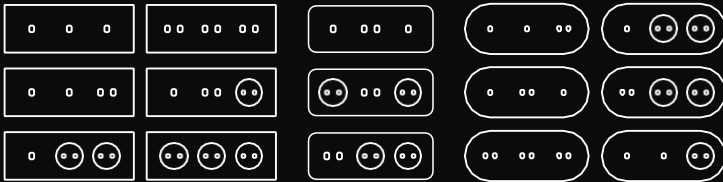

Cadre 3 postes vertical

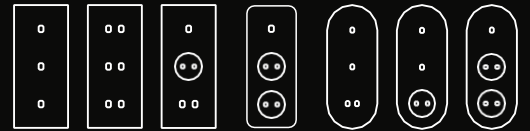

Cadre 4 postes horizontal

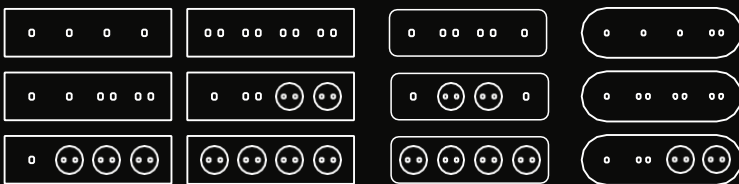

Cadre 4 postes vertical

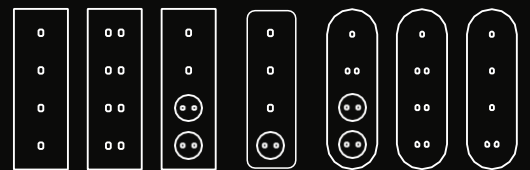

Quintuple cadre horizontal

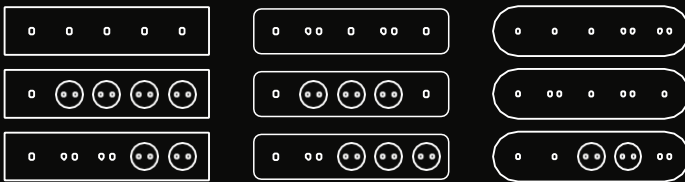

Quintuple cadre vertical

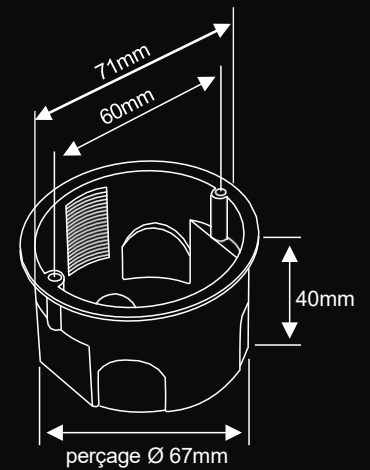
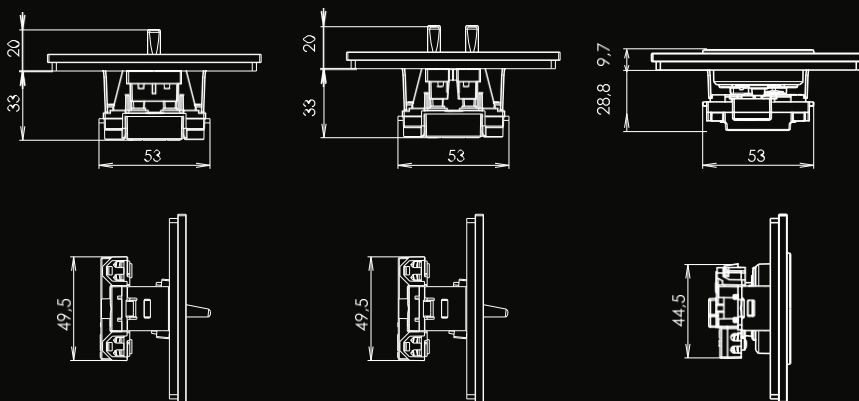
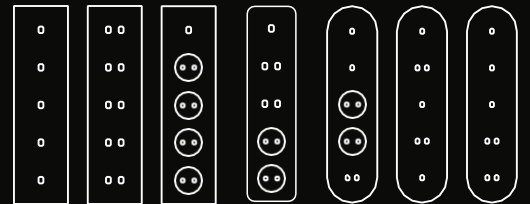

Montage dans des boîtes standard (type batibox) de Ø60mm – entraxe 71mm (simple et multiple, modulaire pour les murs en maçonnerie et en plaque de plâtre).



www.ecoome.fr

facebook | ecoome

instagram | ecoome_interrupteurs_design

Contact

Vincent MIELCAREK

+33 (0)7 82 73 69 92
vincent.mielcarek@ecoome.fr